



TECHNICAL AND FUNCTIONAL CHARACTERISTICS

- Gas-fired burner.
- Single stage operation (on/off).
- Ability to operate with any type of combustion chamber.
- Air-gas mixing at blast-pipe.
- Ability to obtain optimal combustion values by regulating combustion air and blast-pipe.
- Maintenance facilitated by the fact that the mixing unit can be removed without having to remove the burner from the boiler.
- Manual air flow adjustment.
- Possibility to chose gas train with valve tightness control.
- Equipped with one 7 pole connector, one flange and one insulating seal for boiler fastening.
- On request: longer blast tube.

CONSTRUCTION CHARACTERISTICS

The burner consists of:

- Light aluminium alloy fan part.
- High performance centrifugal fan.
- Combustion air inlet with device to adjust the air flow; automatically closing air gate.
- Sliding boiler coupling flange to adapt the head protrusion to the various types of boilers.
- Adjustable combustion head complete with blast tube (stainless steel for BTG 11) and steel deflector disk.
- Monophase electric motor to run fan.
- Air pressure switch to ensure the presence of combustion air.
- Gas train complete with operation and safety valve, minimum pressure switch, pressure regulator and gas filter.
- Automatic control and command equipment for the burner, compliant with European standard EN298.
- Flame detection by ionisation electrode.
- 7 pole outlet for burner electrical and thermostat connections.
- Prepared for microamperometer connection with ionisation cable.
- Electrical protection rating IP40.
- Sound-proof plastic protective cover.

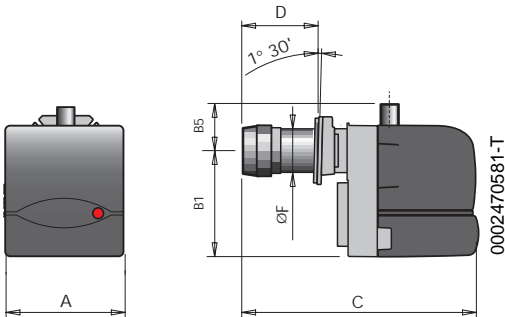

Conforms to:
 Gas Directive 90/396/CEE
 E.M.C. Directive 89/336/CEE
 L.V. Directive 73/23/CEE
 Reference standard: EN676

Thermal output kW	Model	Part no.	Electrical supply	Motor kW	A mm	B 1 mm	B 5 mm	C mm	D mm	F mm	Size of packaging L x P x H mm	Weight kg	Notes
Frequency 50 Hz													
16.3 - 41.9	BTG 3,6	17020010	1N AC 50Hz 230V	0.11	245	218.5	53	410	50 - 105	90	500 x 300 x 320	12	1)
30.6 - 56.3	BTG 6	17040010	1N AC 50Hz 230V	0.11	245	218.5	53	410	50 - 105	90	500 x 300 x 320	12	1)
48.8 ÷ 99	BTG 11	17060010	1N AC 50Hz 230V	0.11	245	218.5	53	475	90 - 150	90	540 x 300 x 320	12	1)

Optionals

Description
300 mm long combustion head

Gas burner accessories

Boiler coupling kit - 7 pin plug

Notes

- 1) Equipped with air closure device.
 - 5) Valve tightness control not required by EN676.
- CTV) Gas train with Valve Tightness Control.
- *) Minimum gas train inlet pressure needed to obtain maximum burner power with a combustion chamber backpressure of zero.
- **) Maximum gas inlet pressure at pressure regulator in CE version, at gas train for EXP version.
- Net calorific value of natural gas: $H_i = 35.80 \text{ MJ/m}^3 = 8550 \text{ kcal/m}^3$, at reference conditions of 0°C, 1013 mbar.

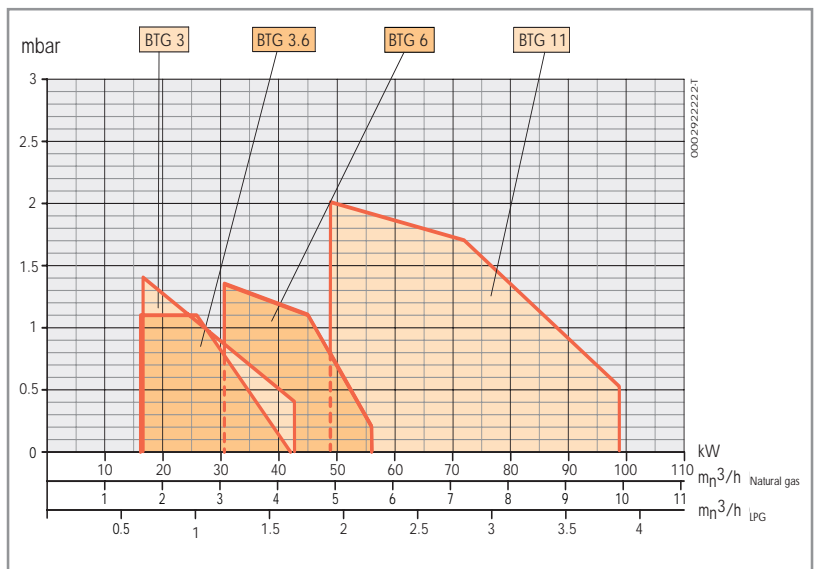

BURNER/GAS TRAIN MATCH - CE gas train version complies with EN676, EXP gas train version is for extra-European markets

Burner model	Gas type	Version	Curve on graph	Execution	P.Max** mbar	Gas train		Regulator with incorporated filter		Burner/gas train adapter		Valve tightness control kit		Pic.	Notes
						Part no.		Part no.		Part no.		Part no.			
BTG 11	NATURAL GAS	CE	4A		200	19990338		Included		96000001		—		M2	
				CTV	200	19990338		Included		96000001		98000100		M2	5)
			4B		360	19990002		Included		—		—		M2	
		CTV		360	19990002		Included		—		98000100		M2	5)	
		EXP	4A		200	19990338		Included		96000001		—		M2	
				CTV	200	19990338		Included		96000001		98000100		M2	
	4B			360	19990002		Included		—		—		M2		
		CTV	360	19990002		Included		—		98000100		M2			
			4J		40	19990235		—		—		—		ME1	

Burner model	Gas type	Version	Execution	P.Gas* mbar	Gas train		Regulator with incorporated filter		Burner/gas train adapter		Valve tightness control kit		Pic.	Notes
					Part no.		Part no.		Part no.		Part no.			
BTG 11	LPG	CE		30	19990338		Included		96000001		—		M2	
			CTV	30	19990338		Included		96000001		98000100		M2	5)
		EXP		30	19990235		—		—		—		ME1	
			CTV	30	19990338		Included		96000001		98000100		M2	

Please see last page for Gas Train Calculations' Example

Head loss (combustion head + gas train + pressure regulator)

BTG 11 Natural gas CE

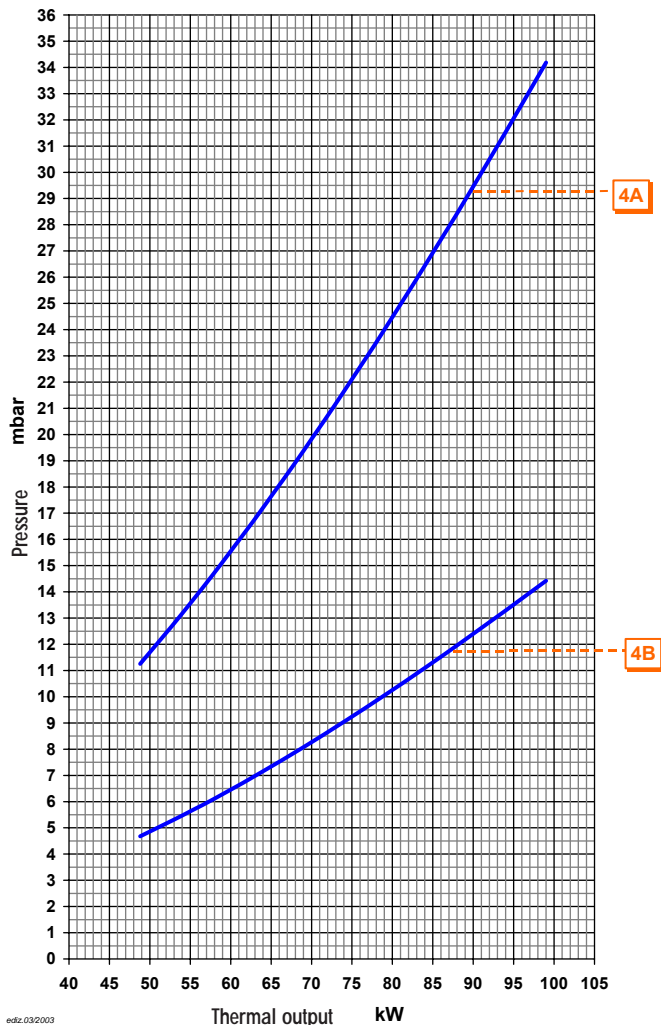

Flange Mounting Dimensions

L		M	N
min	max		
130	155	M8	110

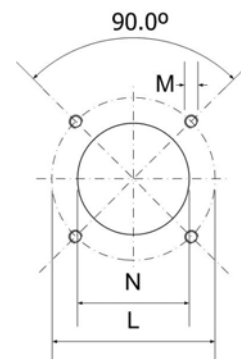

PICTURE ME1

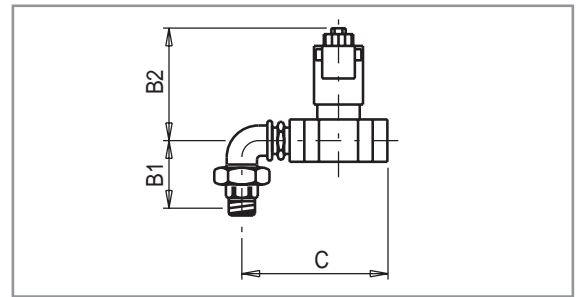
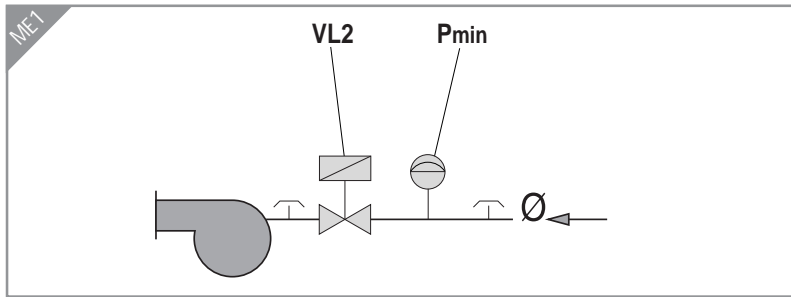

Gas train part no.	Pmin	Position VL	Ø	Gas train dimensions mm			Size of packaging mm L x P x H	Weight kg
				B1	B2	C		
19990004	●	3/4"	3/4"	72	177	114	240 x 220 x 210	3
19990134	●	1"	1"	83	177	160	240 x 220 x 210	4
19990143	●	1/2"	1/2"	66	123	94	240 x 220 x 210	2
19990235	●	1/2"	1/2"	72	151	110	240 x 220 x 210	2

PICTURE M2

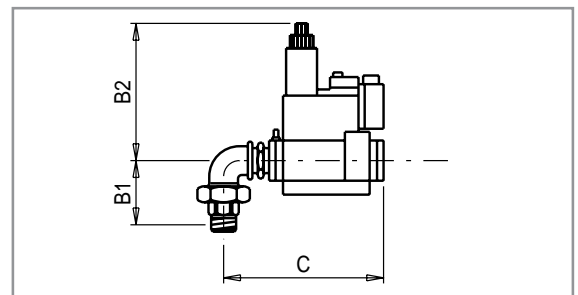
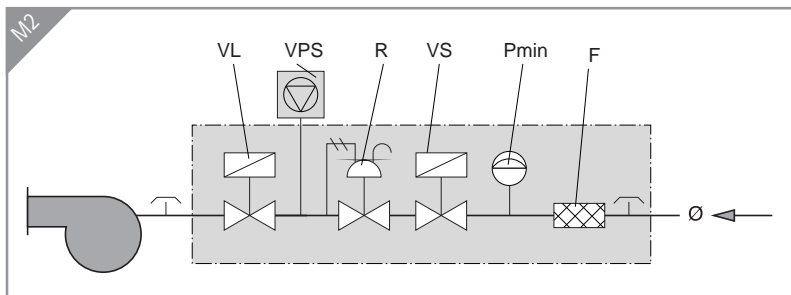

Gas train part no.	F	Pmin	R	Position VL	VPS	VS	Ø	Gas train dimensions mm			Size of packaging mm L x P x H	Weight kg
								B1	B2	C		
19990002 (MB... 405)	●	●	●	●		●	3/4"	72	150	204	310 x 210 x 250	4
19990005 (MB... 407)	●	●	●	●		●	3/4"	72	150	204	310 x 210 x 250	4
19990008 (MB... 410)	●	●	●	●		●	1 1/4"	95	162	249	310 x 210 x 250	7
19990166 (MB... 412)	●	●	●	●		●	1 1/4"	95	162	249	310 x 210 x 250	7
19990332 (MB... 405)	●	●	●	●	●	●	3/4"	72	150	204	310 x 210 x 250	5
19990338 (MB... 403)	●	●	●	●		●	1/2"	67	150	198	210 x 150 x 160	2

Legend

CTV - Valve tightness control	Pmin - Minimum pressure switch	RP - Pneumatic regulator	VPS - VPS valve tightness control
F - Filter	R - Pressure regulator	VF - Regulator throttle valve	VS - Safety valve
LDU - LDU valve tightness control	RF - Pressure regulator with filter	VL - Operating valve	VSP - Safety pilot valve
Pct - Pressure switch for gas control	RFP - Pressure regulator with filter for pilot gas train	VL2 - Two-stage operating valve	Ø - Gas train diameter
Pmax - Maximum pressure switch	RM - Manual flow rate regulator	VLP - Operating pilot valve	Ø1 - Main gas train diameter
Pmc - Minimum and control pressure switch gas leaks		VP - Pilot valve	Ø2 - Pilot gas train diameter

Using the specific diagrams, it is possible to select the gas train that is most suitable for the burner.

First of all it is necessary to identify:

- Burner's heat input Q_i [kW], to be identified along the x-coordinate.
- Gas pressure available at the regulator P_g [mbar], to be identified along the y-coordinate.

The available gas pressure is determined by the formula: $P_g = P_a - P_c$

where:

- P_a = gas pressure provided by the mains supply;
- P_c = the pressure in the boiler combustion chamber.

The intersection point of the two lines defines the operational parameters of the gas train.

The gas train characterised by the first curve underneath the intersection point must be chosen.

EXAMPLE

- Burner = BGN 200
 - $Q_i = 1700$ kW
 - $P_a = 44.5$ mbar
 - $P_c = 2.5$ mbar
 - $P_g = 44.5 - 2.5 = 42$ mbar
- Choose the indicated curve 20C.

The red segment of the curve indicates that the neutral-coloured spring of the regulator must be replaced with the red one (supplied).

To identify the codes for the gas train, pressure regulator and adapter to be ordered refer to the BURNER/TRAIN MATCH-UP TABLE relative to burner BGN200 and CURVE REFERENCE 20C.

Note:

In the graphs the head loss curves have different colours.

The mono-colour BLUE curve represents a gas train with a monoblock valve. The mono-colour ORANGE curve represents a gas train with a mono-valve or with separate valves without pressure regulator; this execution does not comply with EN676 regulation.

The multi-colour curve represents a gas train with separate valves and pressure regulator (this version complies with EN676 regulation). The coloured segments identify the colour of the spring with which the regulator should be used under those specific flow rate/pressure conditions. The pressure regulator is supplied with different-coloured springs (green, red and violet): these are used to replace the one already installed (neutral colour) at the time of installation if necessary.

