

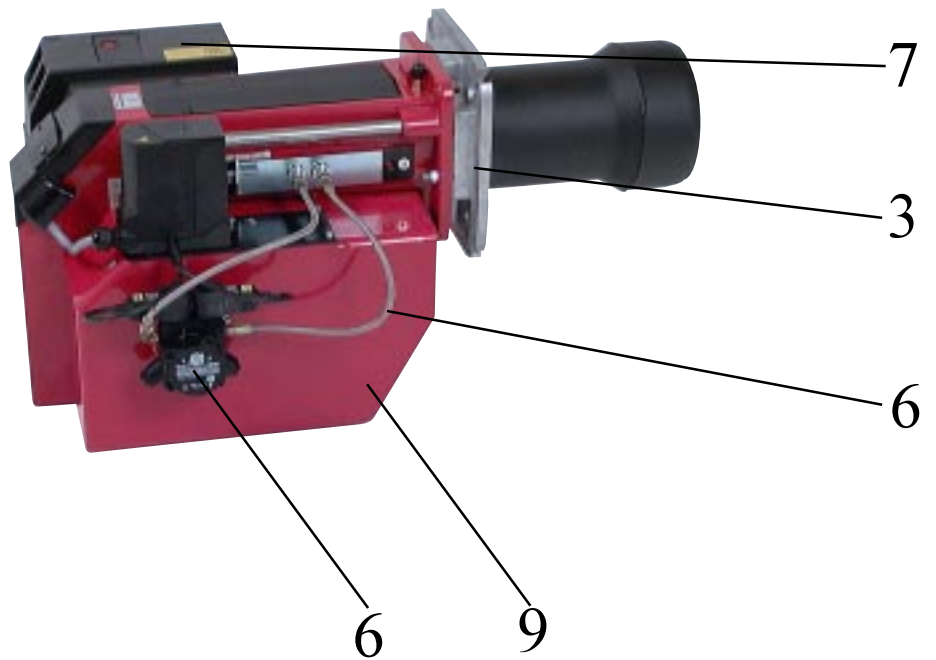

45

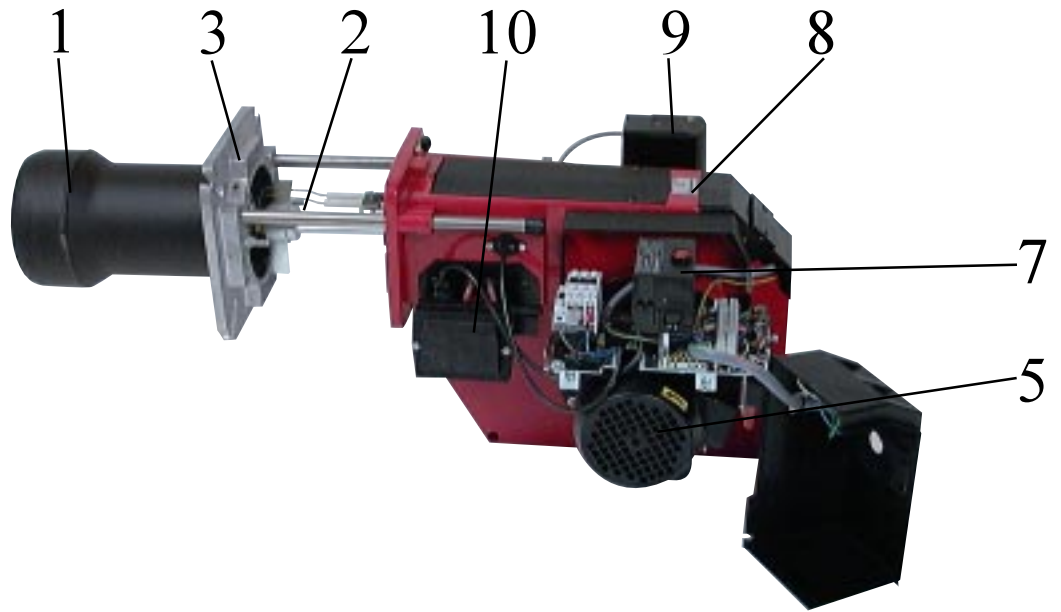

INNEHÅLLSFÖRTECKNING

1. BRÄNNARRÖR	Brännarrör Övrigt	
2. INSATS	Insats Oljerör Bromsskiva	Övrigt
3. ANSLUTNINGSFLÄNS	Anslutningsfläns Packning Övrigt	
4. KÅPA	Kåpa Fäste Övrigt	
5. MOTOR	Motor Kondensator Fläkthjul	Koppling Övrigt
6. PUMP	Pump Magnetventil Filter	Förbindelserör Övrigt
7. ELDNINGSAUTOMAT	Eldningsautomat Fotomotstånd Övrigt	
8. FLÄKTHUS	Fläkthus Övrigt	
9. LUFTREGLERING	Luftreglering Övrigt	
10. TRANSFORMATOR	Transformator Övrigt	
11. SLANG	Slang Övrigt	

TABLE OF CONTENTS

1. BURNER TUBE	Burner tube Other articles	
2. NOZZLE ASSEMBLY	Nozzle assembly Nozzle line Shrouded disc	Other articles
3. FIXING FLANGE	Fixing flange Gasket Other articles	
4. COVER	Cover Attachment Other articles	
5. MOTOR	Motor Capacitor Fan wheel	Coupling Other articles
6. PUMP	Pump Solenoid valve Filter	Connecting pipe Other articles
7. OIL BURNER CONTROL	Oil burner control Photoresistor Other articles	
8. FAN HOUSING	Fan housing Other articles	
9. AIR REGULATION	Air regulation Other articles	
10. TRANSFORMER	Transformer Other articles	
11. FLEXIBLE PIPE	Flexible pipe Other articles	

INHALTSVERZEICHNIS

1. BRENNERROHR	Brennerrohr Sonstiges	
2. DÜSENSTOCK	Düsenstock Düsenrohr Stauscheibe	Sonstiges
3. BEFESTIGUNGS- FLANSCH	Anschlussflansch Dichtung Sonstiges	
4. ABDECKHAUBE	Abdeckhaube Befestigung Sonstiges	
5. MOTOR	Motor Kondensator Gebläserad	Kupplung Sonstiges
6. PUMPE	Pumpe Magnetventil Filter	Öldruckrohr Sonstiges
7. FEUERUNGSAUTOMAT	Feuerungsautomat Fotowiderstand Sonstiges	
8. BRENNERGEHÄUSE	Brennergehäuse Sonstiges	
9. LUFTEINSTELLUNG	LuftEinstellung Sonstiges	
10. TRANSFORMATOR	Transformator Sonstiges	
11. NIPPEL	Ölschlauch Sonstiges	

TABLE DES MATIERES

1. TUBE DIFFUSEUR	Tube diffuseur D'autres articles	
2. LIGNE PORTE- GICLEUR	Ligne porte-gicleur Canne porte-gicleur Disque accroche-flamme	D'autres articles
3. BRIDE DE FIXATION	Bride de fixation Joint D'autres articles	
4. CAPOT	Capot Fixation D'autres articles	
5. MOTEUR	Moteur Condensateur Rotor	Manchon D'autres articles
6. POMPE	Pompe Electrovanne Filtre	Trompette D'autres articles
7. COFFRET DE SECURITE	Coffret de sécurité Cellule photorésistante D'autres articles	
8. CARTER DU ROTOR	Carter du rotor D'autres articles	
9. REGLAGE D'AIR	Réglage d'air D'autres articles	
10. TRANSFORMATEUR	Transformateur D'autres articles	
11. FLEXIBLE	Flexible D'autres articles	



Brännarrör
270 mm
370 mm

Burner tube
270 mm
370 mm

Brennerrohr
270 mm
370 mm

Tube diffuseur
270 mm
370 mm

119 349 0105
119 349 0205

	Insats Standard Långt utförande	Nozzle assembly Standard Long design	Düsenstock Standard Längere Ausf.	Ligne porte- gicleur Standard Modèle long	119 546 01 119 546 02
	Oljerör Standard Långt utförande	Nozzle line Standard Long design	Düsenrohr Standard Längere Ausf.	Canne porte- gicleur Standard Modèle long	118 478 01 118 478 02
	Bromsskiva	Brake plate	Stauscheibe	Disque accroche- flamme	119 347 01
	Tändeledrod- par	Pair of ignition electrodes	Zündeledroden- paar	Electrode d'allumage, 1 paire	919 245 01
	Klammer	Bracket	Klammer	Support	112 738 01
	Ställplatta kpl	Adjustment plate compl.	Stellplatte kompl.	Platine de réglage compl.	118 229 01
	Axel kpl. A2.2R	Axle compl. A2.2R	Welle kompl. A2.2R	Arbre compl. A2.2R	918 298 02
	Reglerdon A2.2R	Adjustment device A2.2R	Regelgerät A2.2R	Dispositif de réglage A2.2R	919 487 01
	Ställplatta kpl. A2.2R	Adjustment plate A2.2R	Stellplatte kompl. A2.2R	Platine de réglage compl. A2.2R	119 468 02
	Packning A2.2R	Gasket A2.2R	Dichtung A2.2R	Joint A2.2R	111 844 01

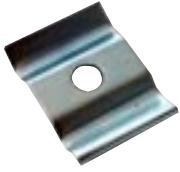

Klammer

Bracket

Klammer

Support

111 552 01



Anslutningsfläns
kompl.
Anslutningsfläns
Gejder

Fixing flange
compl.
Fixing flange
Guide bars

Anschlussflansch
kompl.
Anschlussflansch
Führungsstäben

Bride de fixation
compl.
Bride de fixation
Barres de
guidage

118 230 02

117 975 01

118 093 01



Packning
fläkthus-fläns

Gasket
fan housing-
flange

Dichtung,
Brennergehäuse-
Flansch

Joint, carter du
rotor-bride

118 397 01



Packning



Gasket

Dichtung

Joint

112 788 02

	Motor 450W, 1-fas 450W, 3-fas Kabel, 3-fas Kabel, 1-fas	Motor 450W, 1-phase 450W, 3-phase Cable, 3-phase Cable, 1-phase	Motor 450W, 1-phasig 450W, 3-phasig Kabel, 3-phasig Kabel, 1-phasig	Moteur 450W, monophasé 450W, triphasé Câble, triphasé Câble, monophasé	119 386 01 119 386 02 119 449 03 119 449 06
	Fläkthjul	Fan wheel	Gebläserad	Rotor	112 776 23
	Avskärmningskon	Conical shield plate	Abschirmkonus	Cône deflecteur d'air	118 954 01
	Kopplingsdel Danfoss Suntec	Coupling part Danfoss Suntec	Kupplungsstück Danfoss Suntec	Manchon d'accouplement Danfoss Suntec	04 390 448 66 04 390 448 68
	Kopplingsände	Coupling part	Kupplungsstück	Manchon d'accouplement	111 279 01
	Drivkoppling kpl. Danfoss Suntec	Drive coupling Danfoss Suntec	Antriebskupplung Danfoss Suntec	Accouplement d'entraînement Danfoss Suntec	111 278 30 111 278 31
	Motorfläns	Flange, motor	Motorflansch	Bride, moteur	119 285 0105

	Pump RSA60 Filtersats A2.2R	Pump RSA60 Filter set A2.2R	Pumpe RSA60 Filtersatz A2.2R	Pompe RSA60 Jeu de filtre A2.2R	110 197 18 117 832 01
	Pump A2L Med kablar Magnetventil Packning, lock A2.2H, A2.2	Pump A2L With cables Solenoid valve Gasket, cover A2.2H, A2.2	Pumpe A2L Mit Kabeln Magnetventil Dichtung, Deckel A2.2H, A2.2	Pompe A2L avec câbles Electrovanne Joint, couvercle A2.2H, A2.2	113 675 26 913 675 26 115 972 04 114 566 01
	Förbindelserör pump-insats	Connecting pipe pump-nozzle assembly	Öldruckrohr Pumpe- Düsenstock	Trompette pompe-ligne porte- gicleur	119 394 01
	Förbindelserör pump-insats	Connecting pipe pump-nozzle assembly	Öldruckrohr Pumpe- Düsenstock	Trompette pompe-ligne porte- gicleur	119 395 01
	Förbindelserör pump-reglerdon	Connecting pipe pump-adjustment device	Öldruckrohr Pumpe-Regelgerät	Trompette pompe-dispositif de réglage	119 484 01
	Hydraulslang	Hydraulic hose	Hydraulischer Ölschlauch	Tuyau hydraulique	118 293 01
	Bussning	Bushing	Buchse	Douille	114 113 02
	Magnetventilblock kpl. Magnetventil Spole Kabel Kabel	Solenoid valve bloc compl. Solenoid valve Coil Cable Cable	Magnetventilblock kompl. Magnetventil Spule Kabel Kabel	Jeu d'electrovanne compl. Electrovanne Bobine Câble Câble	117 994 01 115 973 05 115 974 03 115 975 03 115 975 04
	Nippel, anslutning	Nipple, connection	Nippel, Anschluss	Raccord, adhérence	118 423 01



Kopparpackning

Copper gasket

Kupferdichtung

Joint en cuivre

110 212 16



Vinkel

Angle



Winkelnippel





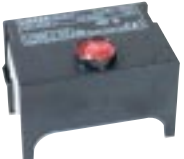

Coude

118 404 01

	Reläbox LOA24	Control box LOA24	Steuergerät, Oberteil LOA24 Industrie	Boite de contrôle LOA24	
	Industriförpackning Styckförpackning	Industrial package Single-piece package	verpackung Stückverpackung	Emballage industriel Emballage par pièces	115 595 07 915 595 07
	Reläbox TF836	Control box TF836	Steuergerät, Oberteil TF836 Industrie	Boite de contrôle TF836	
	Industriförpackning Styckförpackning	Industrial package Single-piece package	verpackung Stückverpackung	Emballage industriel Emballage par pièces	117 027 02 917 027 02
	Reläsockel LOA	Control base LOA	Steuergerät, Unterteil LOA	Socle de raccordement, boite de contrôle LOA	915 596 00
	Reläsockel Satronic	Control base Satronic	Steuergerät, Unterteil Satronic	Socle de raccordement, boite de contrôle Satronic	918 448 01
	Fotomotstånd QRB1-A kpl.	Photoresistor QRB1-A compl.	Fotowiderstand QRB1-A kompl.	Cellule photorésistante QRB1-A compl.	912 409 00
	Fotomotstånd MZ770	Photoresistor MZ770	Fotowiderstand MZ770	Cellule photorésistante MZ770	04 390 295 67
	Fläns, fotomotstånd QRB	Flange, photoresistor QRB	Flansch, Fotowiderstand QRB	Bride, cellule photorésistante QRB	112 405 01
	Fläns, fotomotstånd MZ	Flange, photoresistor MZ	Flansch, Fotowiderstand MZ	Bride, cellule photorésistante MZ	390 113 03
	Kontaktor	Contacteur	Kontaktor	Contacteur	113 110 01

	Kontaktidon	Plug-in contact	Stecker und Buchsenteil	Fiche de prise de courant	
	4+7 pol	4+7-pole	4+7-polig Stecker	4+7-polaire	119 333 01
	7 pol, hane	male, 7-pole	7-polig Buchsenteil	mâle, 7-polaire	115 585 00
	7 pol, hona	female, 7-pole	7-polig Stecker	femelle, 7-polaire	119 098 04
	4 pol, hane	male, 4-pole	4-polig Buchsenteil	mâle, 4-polaire	119 197 01
	4 pol, hona	female, 4-pole	4-polig	femelle, 4-polaire	119 198 01
	Strömbrytare	Switch	Schalter	Interrupteur	117 212 01
	Omkopplare HI	Switch HI	Umschalter HI	Commutateur HI	117 212 02
	Indikeringslampa grön	Indicating lamp green	Anzeigelampe grün	Lampe témoin verte	117 211 03
	Timräknare	Time meter	Betriebsstunden-zähler	Compteur horaire	117 678 01
	Överströmsskydd 1,8-2,8A	Thermal overload 1,8-2,8A	Überstromschutz 1,8-2,8A	Déclencheur à maxima d'intensité 1,8-2,8A	113 111 06
	Reläbox TF832.3	Controlbox TF832.3	Steuergerät, Oberteil TF832.3	Boite de contrôle TF832.3	
	Industriförpackning	Industrial package	Industrie verpackung	Emballage industriel	117 810 07
	Styckförpackning	Single-piece package	Stückverpackung	Emballage par pièces	917 810 07

	Reläbox LOA44	Controlbox LOA44	Steuergerät, Oberteil LOA44 Industrie	Boite de contrôle LOA44	
	Industriförpackning	Industrial package Single-piece	verpackung	Emballage industriel	115 595 02
	Styckförpackning	package	Stückverpackung	Emballage par pièces	915 595 02
	Reläbox LAL	Controlbox LAL	Steuergerät, Oberteil LAL Industrie	Boite de contrôle LAL	
	Industriförpackning	Industrial package Single-piece	verpackung	Emballage industriel	114 939 01
	Styckförpackning	package	Stückverpackung	Emballage par pièces	914 939 01
	Reläsocket LAL	Control base LAL	Steuergerät, unterteil LAL	Sockette de raccordement, boite de contrôle LAL	114 942 00

	Lock kpl.	Cover compl.	Deckel kompl.	Couvercle compl.	117 649 0105
	Skyddsgaller	Protective grating	Schutzgitter	Grille de protection	119 302 01
	Kåpa, inspektionsglas Inspektionslock	Cover, inspection glass Inspection cover	Haube, Schauglas Deckel, Schauglas	Capot, viseur de flamme Couvercle, viseur de flamme	117 963 0205 117 080 01
	Inspektionsglas	Inspection glass	Schauglas	Viseur de flamme	118 088 01
	Packning	Gasket	Dichtung	Joint	117 953 01
	Säkringsring	Locking ring	Sicherungsring	Circlip	118 018 01
	Packning	Gasket	Dichtung	Joint	117 783 01

	Spjällmotor Landis & Stefa SQN75.244A21B 2-steg LOA, TF	Servo motor Landis & Stefa SQN75.244A21B 2-stage, LOA, TF	Stellmotor Landis & Stefa SQN75.244A21B 2-stufig, LOA, TF	Servo moteur Landis & Stefa SQN75.244A21B 2-allures, LOA, TF	119 423 04
	SQN75.294A21B 2-steg, LAL	SQN75.294A21B 2-stage, LAL	SQN75.294A21B 2-stufig, LAL	SQN75.294A21B 2-allures, LAL	119 423 03
	Reglerdon kpl. A2.2H	Adjustment device compl. A2.2H	Regelgerät kompl. A2.2H	Dispositif de réglage compl. A2.2H	917 565 14
	Fjäder kpl. A2.2H	Spring compl. A2.2H	Feder kompl. A2.2H	Ressort compl. A2.2H	113 799 01
	Packning A2.2H	Gasket A2.2H	Dichtung A2.2H	Joint A2.2H	111 844 01
	Fästplatta	Covering plate	Deckplatte	Plaque de recouvrement	
	A2.2R, A2.2 A2.2H	A2.2R, A2.2 A2.2H	A2.2R, A2.2 A2.2H	A2.2R, A2.2 A2.2H	117 978 01
	Pinnskruv	Stud screw	Stiftschraube	Vis à goupille	119 203 01
	Luftspjäll kpl A2.2R, A2.2 A2.2H	Air damper, compl. A2.2R, A2.2 A2.2H	Luftklappe kompl. A2.2R, A2.2 A2.2H	Volet d'air compl. A2.2R, A2.2 A2.2H	918 866 01 918 866 02
	Länkarm kpl.	Slewing bracket compl.	Gelenkarm kompl.	Pivot compl.	119 470 01
	Mät nipple	Test nipple	Messnippel	Raccord de mesure	118 053 01



Transformator

Transformer

Transformator

Transformateur

118 046 01

Kabel

Cable

Kabel

Câble

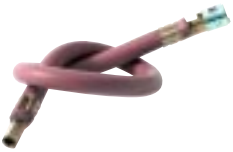
118 047 01Tändkabel
250 mm
330 mmIgnition cable
250 mm
330 mmZündkabel
250 mm
330 mmCâble H.T.
250 mm
330 mm**118 049 01****118 049 02**



Oljeslang

Flexible pipe

Ölschlauch

Flexible

110 272 09